

GHC50 Product Guide

ASME B30.5
Metric 75% and Imperial 75%



Features

- 45 t (50 USt) capacity
- 9,4 m – 30,4 m (30 ft 10 in – 99 ft 9 in) four-section full power boom
- 13 m (42 ft 8 in) offsettable boom extension
- 100% pick and carry load charts
- Cummins QSB 4.5L Tier 4 final compliant engine

GROVE GHC50

A compact powerhouse, the GHC50 transports to the jobsite on one truck, with low gross vehicle weight and ground-bearing pressure and a boom measuring 9,4 m – 30,4 m (30 ft 10 in – 99 ft 9 in).

Features

> Comfort redefined

Operator cab is designed to deliver maximum comfort while incorporating conveniently located joystick controls for precise operation. Cab comes equipped with an integrated rated capacity limiter, air suspension seat, color monitor for up to four cameras and precise climate control. The cab can tilt up to 15° providing the operator additional comfort when working at long boom and extension lengths.



> Travel made easy

Transportation to the jobsite can easily be accomplished in one load. Once on the jobsite, the GHC50's narrow dimensions provide excellent maneuverability in confined areas. The strong undercarriage provides 100 percent pick and carry capability and work up to 4° of inclination. The hydraulically extendable tracks allow for three working gauges for maximum flexibility on the job.



> Strong telescopic boom

The GHC50 comes equipped with a robust full-power four-section boom that allows for telescoping under load. The main boom offers 9,4 m – 30,4 m (30 ft 10 in – 99 ft 9 in) of reach. This paired with the standard 6,5 m (21 ft 4 in) offsettable swingaway extension provides a maximum tip height of 39,3 m (129 ft).



CraneSTAR®

> CraneSTAR is an exclusive and innovative crane asset management system

that helps improve your profitability and reduce costs by remotely monitoring critical crane data.

Visit www.cranestar.com for more information.

GHC50 benefits

More productive in more places on the jobsite

The GHC50 delivers unsurpassed maneuverability and versatility.

- Telescoping boom, plus heavy-duty crawler tracks for all-terrain productivity
- Superior gradeability
- High visibility cabs with up to 15° tilt
- Two-speed hydrostatic drive allows for skid steering and counter-rotation capability
- Compact design allows you to work in more places

Rugged durability to tackle all terrain

The GHC50 comes equipped with a durable, powerful crawler system.

- Hydraulically extendable and retractable crawlers
- Heavy-duty, 900 mm (36 in) triple bar, maintenance-free track shoes
- Cummins QSB Tier 3 or Tier 4 final diesel engines power through terrain challenges

Easy transport to the jobsite and quick assembly

The GHC50 helps you spend less time on the truck and more time on the job.

- Transports to the jobsite in one load
- Retracted gauge for transport width
- Excellent serviceability keeps you up and running



Maniowoc Crane Care when you need it.

The assurance of the world's most advanced crane service and support to get you back to work fast.



Maniowoc Finance helps you get right to work generating profits for your business.

Financial tools that help you capitalize on opportunity with solutions that fit your needs.

Contents

- Dimensions 5
- Load programs 7
- Working range/ load charts – main boom metric 75% 8
- Working range/load charts – extensions metric 75% 11
- Working range/ load charts – main boom imperial 75% 14
- Working range/ load charts – extensions imperial 75% 17
- Load handling 20
- Specifications 21
- Symbols glossary 23

Dimensions

Transport dimensions and weights

Operating / Transport weight:

Approximately 45 770 kg (100,905 lb) with 6,5 m (21 ft 4 in) boom extension, two hoists, 900 mm (36 in) triple bar shoes and 8900 kg (19,621 lb) counterweight.

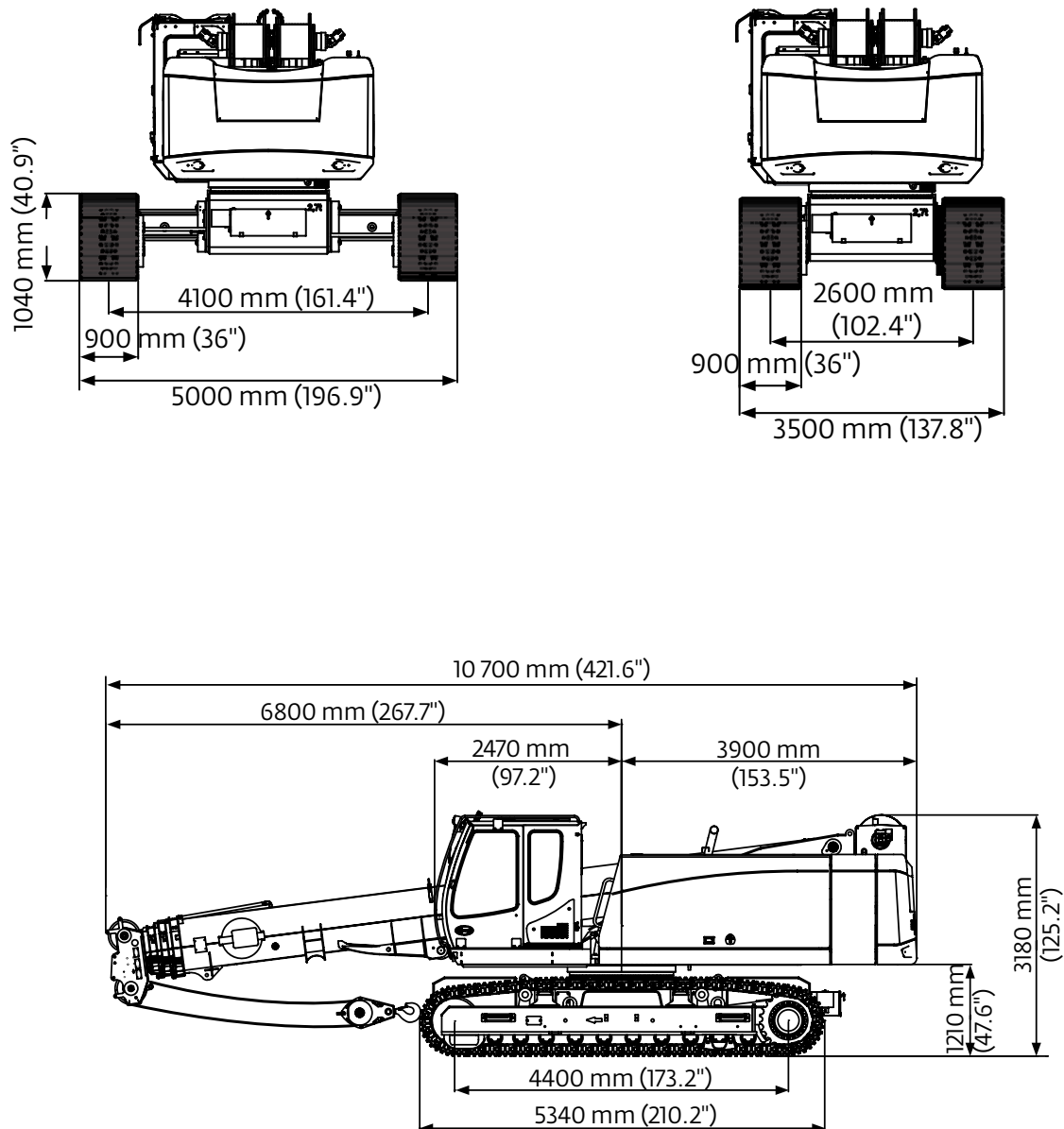

Dimensions

Transport dimensions and weights

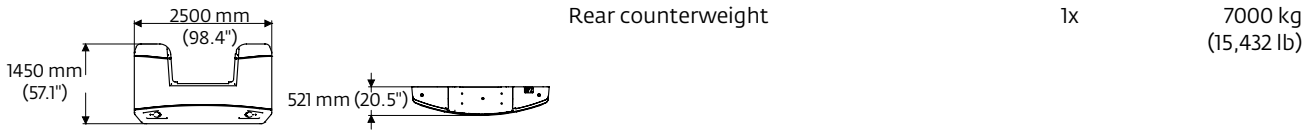

Rear counterweight

1x

7000 kg
(15,432 lb)

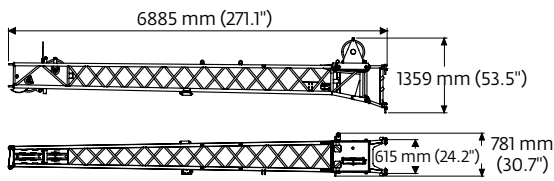

Boom extension - 6,5 m (21 ft 4 in)

600 kg
(1323 lb)

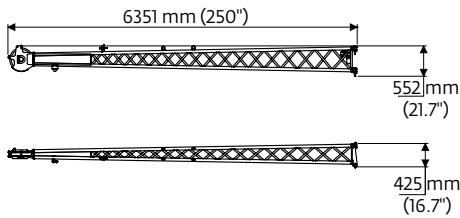

Fly jib extension - 6,5 m (21 ft 4 in)

250 kg
(551 lb)

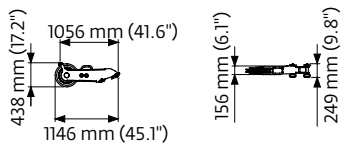









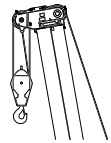
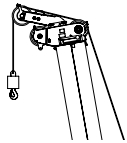
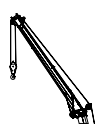













Auxiliary boom nose

50 kg
(110 lb)

Load programs

Working load programs

	Main boom			Auxiliary boom nose			Boom extension 6,5 m (21 ft 4 in)			Boom extension with optional fly jib 13 m (42 ft 8 in)		
												
Counterweight												
Undercarriage track width (centerline to centerline of crawlers)	 4,1 m (13' 6")	 3,3 m (10' 10")	 2,6 m (8' 6")	 4,1 m (13' 6")	 3,3 m (10' 10")	 2,6 m (8' 6")	 4,1 m (13' 6")	 3,3 m (10' 10")	 2,6 m (8' 6")	 4,1 m (13' 6")	 3,3 m (10' 10")	 2,6 m (8' 6")
 8,9 t (19,621 lb)	360° 	360° 	360° 	360° 	360° 	360° 	360° 	—	—	360° 	—	—

Note:

Additional safe working loads are also available for 2° and 4° inclines.

Boom extension options

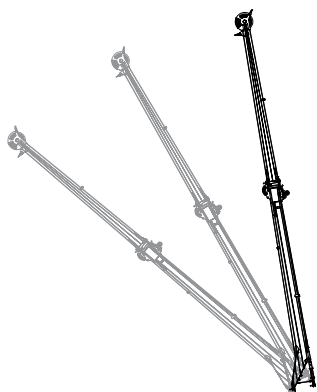

• **Boom extension 6,5 m (21 ft 4 in)**
maximum 2-strand, possible offset angle 0° and 40°



• **Boom extension w/ optional fly jib
13 m (42 ft 8 in)**
maximum 1-strand, possible offset angle 0° and 40°



• **Auxiliary boom nose**
maximum 1-strand

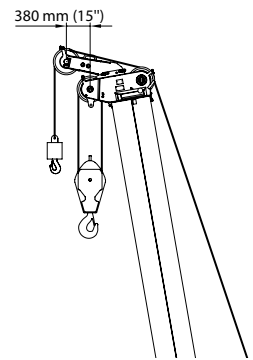

Capacity	Weight	Cable reeving and maximum safe working load										
		10	9	8	7	6	5	4	3	2	1	
5 t (5.5 USt)	80 kg (176 lb)	—	—	—	—	—	—	—	—	—	—	5000 kg (11,000 lb)
35 t (38.5 USt) 3-sheave	270 kg (595 lb)	—	—	—	35 000 kg (77,000 lb)	30 000 kg (66,000 lb)	25 000 kg (55,000 lb)	20 000 kg (44,000 lb)	15 000 kg (33,000 lb)	10 000 kg (22,000 lb)	5000 kg (11,000 lb)	5000 kg (11,000 lb)
60 t (66.1 USt) 6-sheave *optional	850 kg (1874 lb)	50 000 kg (110,000 lb)	45 000 kg (99,000 lb)	40 000 kg (88,000 lb)	35 000 kg (77,000 lb)	30 000 kg (66,000 lb)	25 000 kg (55,000 lb)	20 000 kg (44,000 lb)	15 000 kg (33,000 lb)	10 000 kg (22,000 lb)	5000 kg (11,000 lb)	5000 kg (11,000 lb)

THIS CHART IS ONLY A GUIDE AND SHOULD NOT BE USED TO OPERATE THE CRANE.
The individual crane's load chart, operating instructions and other instructional plates must be read and understood prior to operating the crane.

Working range

Main boom – metric 75%

Main boom

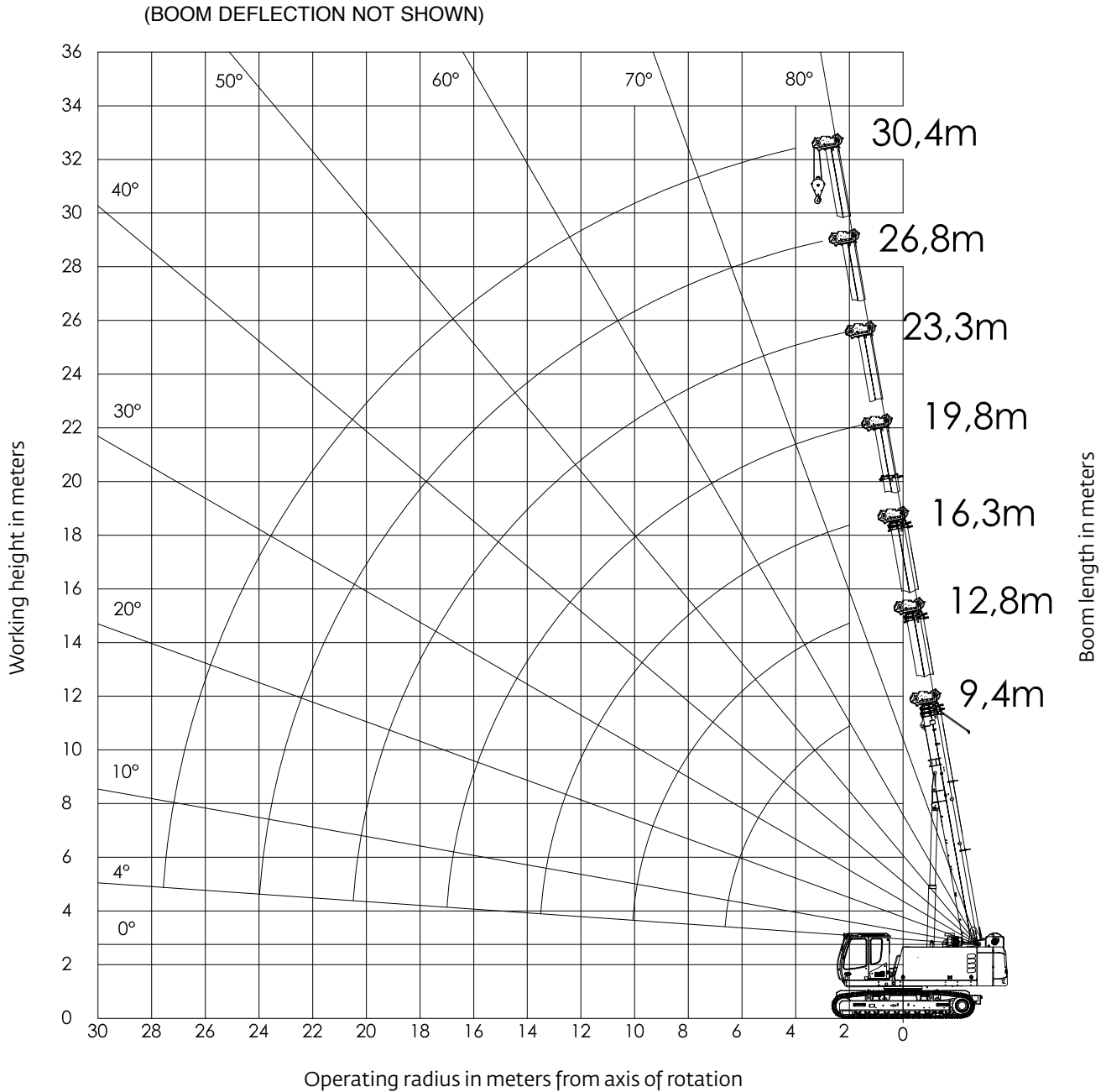

THIS CHART IS ONLY A GUIDE AND SHOULD NOT BE USED TO OPERATE THE CRANE.

The individual crane's load chart, operating instructions and other instructional plates must be read and understood prior to operating the crane.

Load chart

Main boom – metric 75%



30,4 m



8,9 t



100%



360°



Kilograms

Radius in meters	Main boom length in meters						
	9.4	12.8	16.3	19.8	23.3	26.8	30.4
2	45 000	31 000	28 000	15 600	14 500	—	—
3	45 000	31 000	25 000	15 600	14 500	12 700	—
4	38 000	31 000	22 000	15 600	14 500	12 600	9200
5	30 000	28 000	19 300	15 600	14 200	12 400	9200
6	22 000	22 500	16 900	14 900	13 600	11 900	9200
7	—	17 500	15 000	13 600	12 500	11 100	9100
8	—	14 200	13 500	12 200	11 200	10 300	8700
9	—	11 700	11 700	11 100	10 200	9 400	8200
10	—	—	9 900	10 100	9 300	8 600	7 800
11	—	—	8 500	8 900	8 500	8 000	7 300
12	—	—	7 400	7 700	7 900	7 300	6 800
13	—	—	6 400	6 800	7 100	6 800	6 400
14	—	—	—	6 000	6 200	6 300	5 900
15	—	—	—	5 400	5 600	5 800	5 600
16	—	—	—	4 800	5 000	5 200	5 200
17	—	—	—	—	4 500	4 700	4 900
18	—	—	—	—	4 100	4 300	4 400
19	—	—	—	—	3 700	3 900	4 100
20	—	—	—	—	3 300	3 600	3 700
21	—	—	—	—	—	3 300	3 400
22	—	—	—	—	—	3 000	3 100
23	—	—	—	—	—	2 700	2 900
24	—	—	—	—	—	—	2 600
25	—	—	—	—	—	—	2 400
26	—	—	—	—	—	—	2 200
When 6.5 m extension is in stowed position, the rated loads must be reduced as follows:							
Reduction of load (kg)	438	323	258	216	186	165	148
When 13 m extension is in stowed position, the rated loads must be reduced as follows:							
Reduction of load (kg)	596	437	347	289	249	218	196
Lifting capacities at 4° boom angle							
Boom angle	Main boom length in meters						
	9.4	12.8	16.3	19.8	23.3	26.8	30.4
4°	18 900 (6.7)	9 900 (10)	6 200 (13.5)	4 500 (17)	3 300 (20.5)	2 600 (24)	300 (27.5)

NOTE: () reference radii in meters.

THIS CHART IS ONLY A GUIDE AND SHOULD NOT BE USED TO OPERATE THE CRANE.
The individual crane's load chart, operating instructions and other instructional plates must be read and understood prior to operating the crane.

Load chart

Auxiliary boom nose – metric 75%



30,4 m



With
auxiliary
boom nose



8,9 t



100%



360°



Kilograms

Radius in meters	Main boom length in meters						
	9.4	12.8	16.3	19.8	23.3	26.8	30.4
2	5000	5000	5000	5000	—	—	—
3	5000	5000	5000	5000	5000	—	—
4	5000	5000	5000	5000	5000	5000	—
5	5000	5000	5000	5000	5000	5000	5000
6	5000	5000	5000	5000	5000	5000	5000
7	5000	5000	5000	5000	5000	5000	5000
8	5000	5000	5000	5000	5000	5000	5000
9	—	5000	5000	5000	5000	5000	5000
10	—	5000	5000	5000	5000	5000	5000
11	—	5000	5000	5000	5000	5000	5000
12	—	—	5000	5000	5000	5000	5000
13	—	—	5000	5000	5000	5000	5000
14	—	—	—	5000	5000	5000	5000
15	—	—	—	5000	5000	5000	4900
16	—	—	—	4700	4900	4900	4600
17	—	—	—	400	4400	4600	4400
18	—	—	—	—	4000	4200	4300
19	—	—	—	—	3600	3800	3900
20	—	—	—	—	3200	3400	3600
21	—	—	—	—	—	3100	3200
22	—	—	—	—	—	2800	3000
23	—	—	—	—	—	2600	2700
24	—	—	—	—	—	2300	2500
25	—	—	—	—	—	—	2200
26	—	—	—	—	—	—	2000
When 6.5 m extension is in stowed position, the rated loads must be reduced as follows:							
Reduction of load (kg)	438	323	258	216	186	165	148
When 13 m extension is in stowed position, the rated loads must be reduced as follows:							
Reduction of load (kg)	596	437	347	289	249	218	196
Lifting capacities at 4° boom angle							
Boom angle	Main boom length in meters						
	9.4	12.8	16.3	19.8	23.3	26.8	30.4
4°	5000 (6.7)	5000 (10)	5000 (13.5)	4200 (17)	3100 (20.5)	2300 (24)	300 (27.5)

NOTE: () reference radii in meters.

THIS CHART IS ONLY A GUIDE AND SHOULD NOT BE USED TO OPERATE THE CRANE.

The individual crane's load chart, operating instructions and other instructional plates must be read and understood prior to operating the crane.

Working range

Extensions – metric 75%

Main boom with extensions

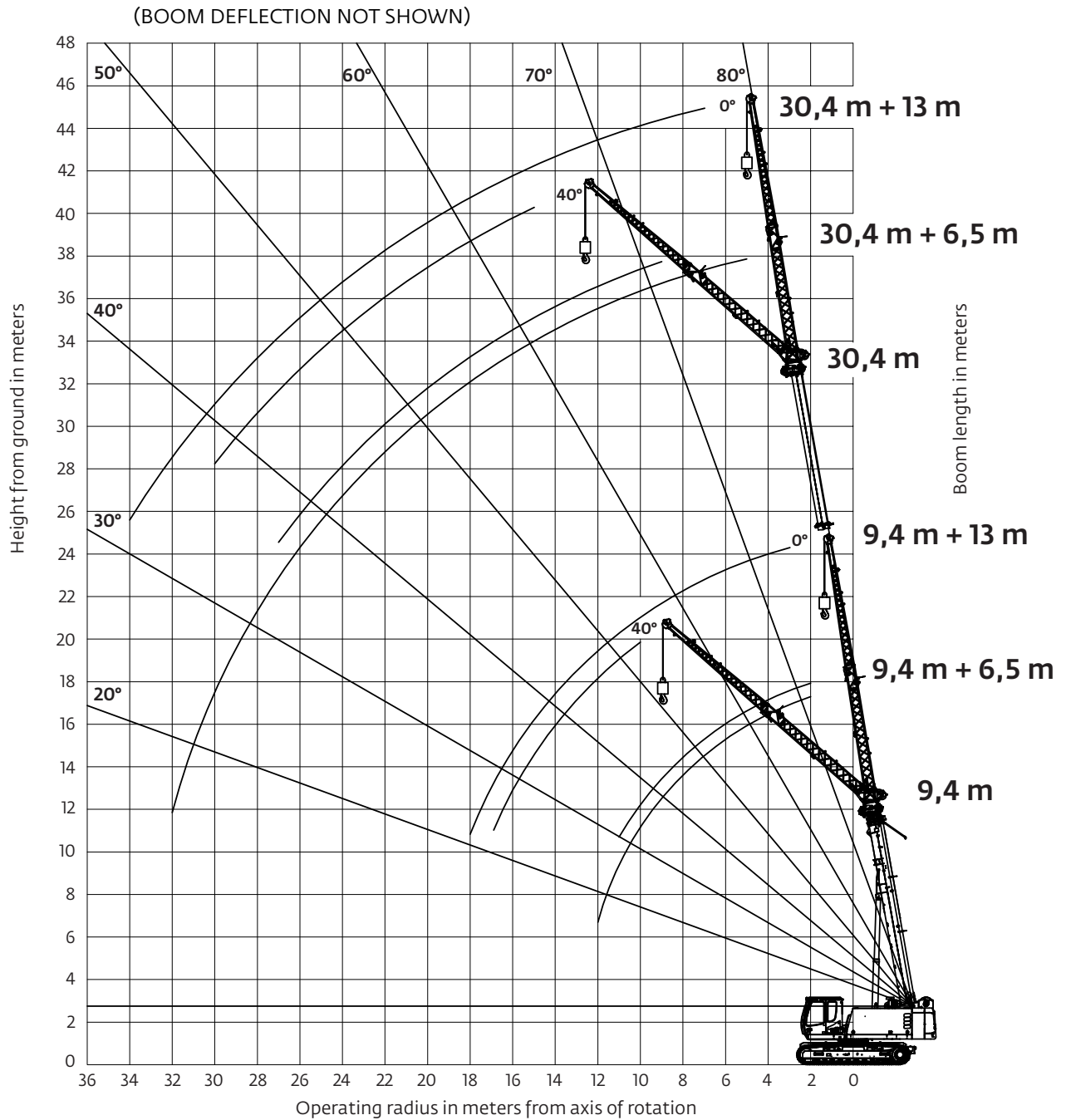

*THIS CHART IS ONLY A GUIDE AND SHOULD NOT BE USED TO OPERATE THE CRANE.
The individual crane's load chart, operating instructions and other instructional plates must be read and understood prior to operating the crane.*

Load chart

Extensions – metric 75%



30,4 m



6,5 m



8,9 t



100%



360°



Kilograms

Radius in meters	Main boom length in meters							
	9,4		16,3		23,3		30,4	
	0°	40°	0°	40°	0°	40°	0°	40°
2	10 000	—	—	—	—	—	—	—
3	9900	—	10 000	—	9900	—	—	—
4	8600	—	9900	—	9400	—	—	—
5	7700	4600	9400	—	9000	—	4900	—
6	6900	4400	8700	4600	8500	—	4800	—
7	6300	4200	8000	4500	8000	4400	4800	—
8	5700	4000	7400	4300	7600	4300	4700	—
9	5200	3900	6900	4200	7200	4200	4700	4000
10	4800	3800	6400	4100	6800	4100	4700	4000
11	4500	3700	6000	4000	6500	4000	4700	3900
12	4100	—	5700	3900	6200	3900	4700	3800
13	—	—	5300	3800	5900	3900	4600	3800
14	—	—	5000	3800	5700	3800	4400	3700
15	—	—	4800	3700	5400	3700	4200	3700
16	—	—	4600	3700	5000	3700	4000	3600
17	—	—	4200	—	4600	3600	3800	3500
18	—	—	4000	—	4200	3600	3700	3400
19	—	—	—	—	3700	3600	3500	3300
20	—	—	—	—	3500	3500	3400	3200
21	—	—	—	—	3200	3300	3200	3100
22	—	—	—	—	2900	—	3000	3000
23	—	—	—	—	2600	—	2700	2800
24	—	—	—	—	2400	—	2400	2600
25	—	—	—	—	—	—	2200	2400
26	—	—	—	—	—	—	2000	2200
27	—	—	—	—	—	—	1800	2000
28	—	—	—	—	—	—	1700	—
29	—	—	—	—	—	—	1500	—
30	—	—	—	—	—	—	1400	—
31	—	—	—	—	—	—	1200	—
32	—	—	—	—	—	—	1100	—

THIS CHART IS ONLY A GUIDE AND SHOULD NOT BE USED TO OPERATE THE CRANE.

The individual crane's load chart, operating instructions and other instructional plates must be read and understood prior to operating the crane.

Load chart

Extensions – metric 75%



30,4 m



13 m



8,9 t



100%



360°



Kilograms

Radius in meters	Main boom length in meters							
	9,4		16,3		23,3		30,4	
	0°	40°	0°	40°	0°	40°	0°	40°
3	4600	—	—	—	—	—	—	—
4	4400	—	4600	—	—	—	—	—
5	4000	—	4400	—	3800	—	—	—
6	3700	—	4100	—	3700	—	—	—
7	3400	—	3800	—	3600	—	2100	—
8	3100	—	3600	—	3400	—	2100	—
9	2900	—	3400	—	3300	—	2100	—
10	2700	1800	3200	—	3100	—	2100	—
11	2500	1700	3000	—	3000	—	2100	—
12	2300	1700	2800	1700	2900	—	2100	—
13	2200	1700	2600	1700	2700	1700	2100	—
14	2000	1600	2500	1700	2600	1600	2100	—
15	1900	1600	2400	1600	2500	1600	2100	1500
16	1800	1500	2300	1600	2400	1600	2100	1500
17	1700	1500	2100	1500	2300	1500	2100	1500
18	1600	—	2000	1500	2200	1500	2100	1500
19	—	—	2000	1500	2100	1500	2000	1400
20	—	—	1900	1500	2100	1500	2000	1400
21	—	—	1800	—	2000	1400	1900	1400
22	—	—	1700	—	1900	1400	1900	1400
23	—	—	1600	—	1800	1400	1800	1400
24	—	—	1500	—	1800	1400	1800	1300
25	—	—	—	—	1700	1400	1700	1300
26	—	—	—	—	1700	1400	1700	1300
27	—	—	—	—	1600	—	1600	1300
28	—	—	—	—	1400	—	1600	1300
29	—	—	—	—	1300	—	1500	1300
30	—	—	—	—	—	—	1500	1100
31	—	—	—	—	—	—	1400	—
32	—	—	—	—	—	—	1200	—
34	—	—	—	—	—	—	1000	—
36	—	—	—	—	—	—	800	—

THIS CHART IS ONLY A GUIDE AND SHOULD NOT BE USED TO OPERATE THE CRANE.

The individual crane's load chart, operating instructions and other instructional plates must be read and understood prior to operating the crane.

Working range

Main boom – imperial 75%

Main boom

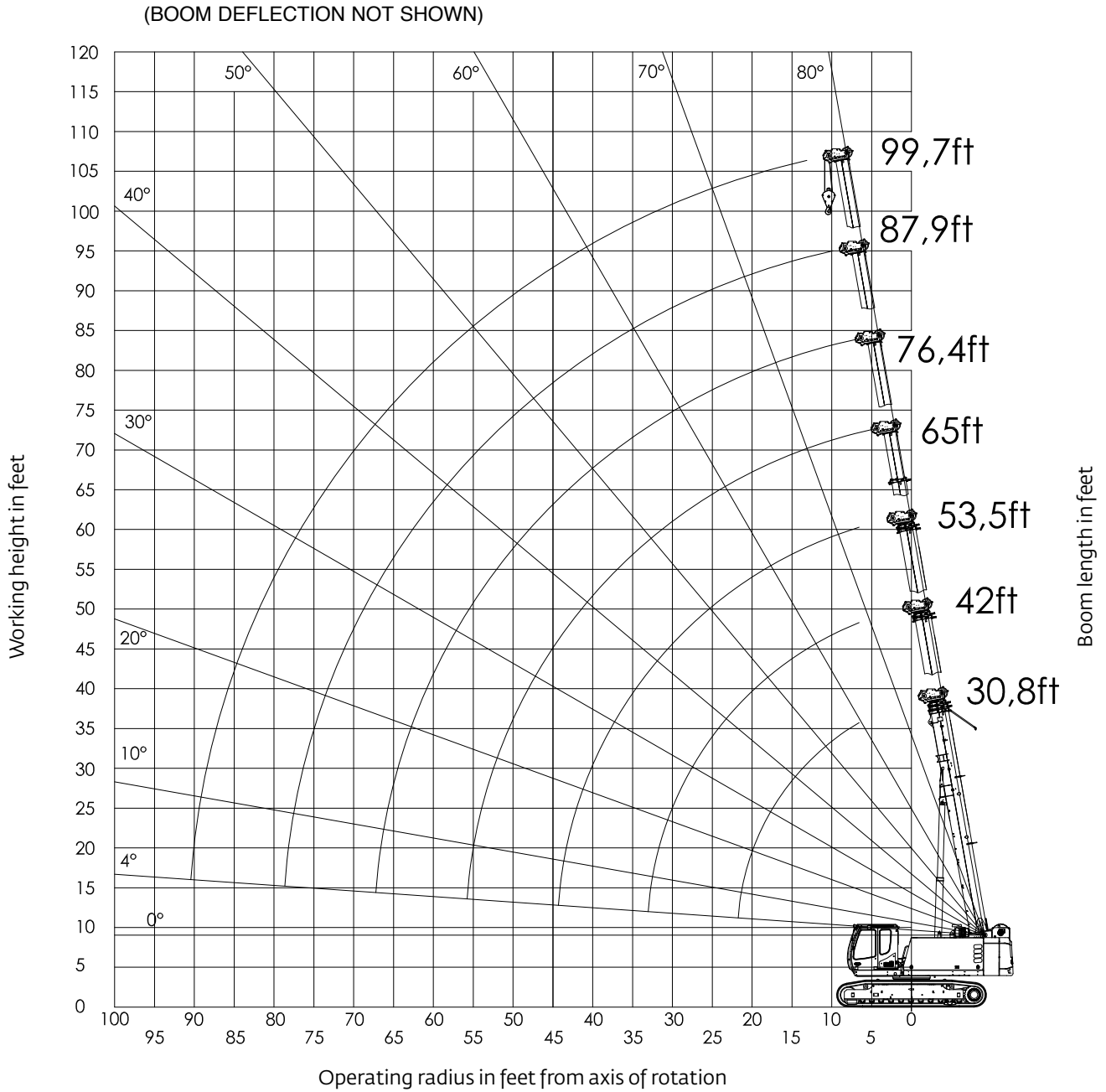

THIS CHART IS ONLY A GUIDE AND SHOULD NOT BE USED TO OPERATE THE CRANE.
 The individual crane's load chart, operating instructions and other instructional plates must be read and understood prior to operating the crane.

Load chart

Main boom – imperial 75%

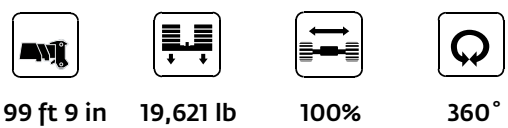

Radius in feet	Main boom length in feet						
	30.8	42.0	53.5	65.0	76.4	87.9	99.7
7	100,000	68,400	61,800	34,400	32,000	—	—
10	98,500	68,400	54,800	34,400	32,000	28,000	—
15	73,700	64,600	45,100	34,400	31,600	27,500	20,300
20	—	48,600	36,900	32,600	29,800	26,100	20,300
25	—	34,100	31,000	28,100	25,800	23,400	19,500
30	—	—	25,200	24,200	22,200	20,500	18,000
35	—	—	19,800	20,500	19,300	18,100	16,500
40	—	—	15,900	16,600	17,100	15,900	14,800
45	—	—	—	13,700	14,200	14,200	13,300
50	—	—	—	11,600	12,000	12,500	12,100
55	—	—	—	—	10,200	10,600	11,000
60	—	—	—	—	8800	9200	9500
65	—	—	—	—	7400	8100	8300
70	—	—	—	—	—	7100	7300
75	—	—	—	—	—	6000	6500
80	—	—	—	—	—	—	5600
85	—	—	—	—	—	—	4900
When 21.3' extension is in stowed position, the rated loads must be reduced as follows:							
Reduction of load (lb)	966	711	568	476	411	363	326
When 42.7' extension is in stowed position, the rated loads must be reduced as follows:							
Reduction of load (lb)	1315	963	766	638	549	481	433
Lifting capacities at 4° boom angle							
Boom angle	Main boom length in feet						
	30.8	42.0	53.5	65.0	76.4	87.9	99.7
4°	41,700 (22.0)	21,800 (32.8)	13,700 (44.3)	9,900 (55.8)	7,300 (67.3)	5,700 (78.7)	700 (90.2)

NOTE: () reference radii in feet.

THIS CHART IS ONLY A GUIDE AND SHOULD NOT BE USED TO OPERATE THE CRANE.
The individual crane's load chart, operating instructions and other instructional plates must be read and understood prior to operating the crane.

Load chart

Auxiliary boom nose – imperial 75%



99 ft 9 in



With auxiliary boom nose



19,621 lb



100%



360°



Pounds

Radius in feet	Main boom length in feet						
	30.8	42.0	53.5	65.0	76.4	87.9	99.7
7	11,000	11,000	11,000	11,000	—	—	—
10	11,000	11,000	11,000	11,000	11,000	—	—
15	11,000	11,000	11,000	11,000	11,000	11,000	—
20	11,000	11,000	11,000	11,000	11,000	11,000	11,000
25	11,000	11,000	11,000	11,000	11,000	11,000	11,000
30	—	11,000	11,000	11,000	11,000	11,000	11,000
35	—	11,000	11,000	11,000	11,000	11,000	11,000
40	—	—	11,000	11,000	11,000	11,000	11,000
45	—	—	—	11,000	11,000	11,000	11,000
50	—	—	—	10,900	11,000	11,000	10,700
55	—	—	—	9500	10,000	10,300	9800
60	—	—	—	—	8600	9000	9200
65	—	—	—	—	7200	7700	8100
70	—	—	—	—	—	6600	6900
75	—	—	—	—	—	5800	6000
80	—	—	—	—	—	—	5300
85	—	—	—	—	—	—	4500
When 21.3' extension is in stowed position, the rated loads must be reduced as follows:							
Reduction of load (lb)	966	711	568	476	411	363	326
When 42.7' extension is in stowed position, the rated loads must be reduced as follows:							
Reduction of load (lb)	1315	963	766	638	549	481	433
Lifting capacities at 4° boom angle							
Boom angle	Main boom length in feet						
	30.8	42.0	53.5	65.0	76.4	87.9	99.7
4°	11,000 (22.0)	11,000 (32.8)	11,000 (44.3)	9,300 (55.8)	6,800 (67.3)	5,100 (78.7)	700 (90.2)

NOTE: () reference radii in feet.

THIS CHART IS ONLY A GUIDE AND SHOULD NOT BE USED TO OPERATE THE CRANE.
The individual crane's load chart, operating instructions and other instructional plates must be read and understood prior to operating the crane.

Working range

Extensions – imperial 75%

Main boom with extensions

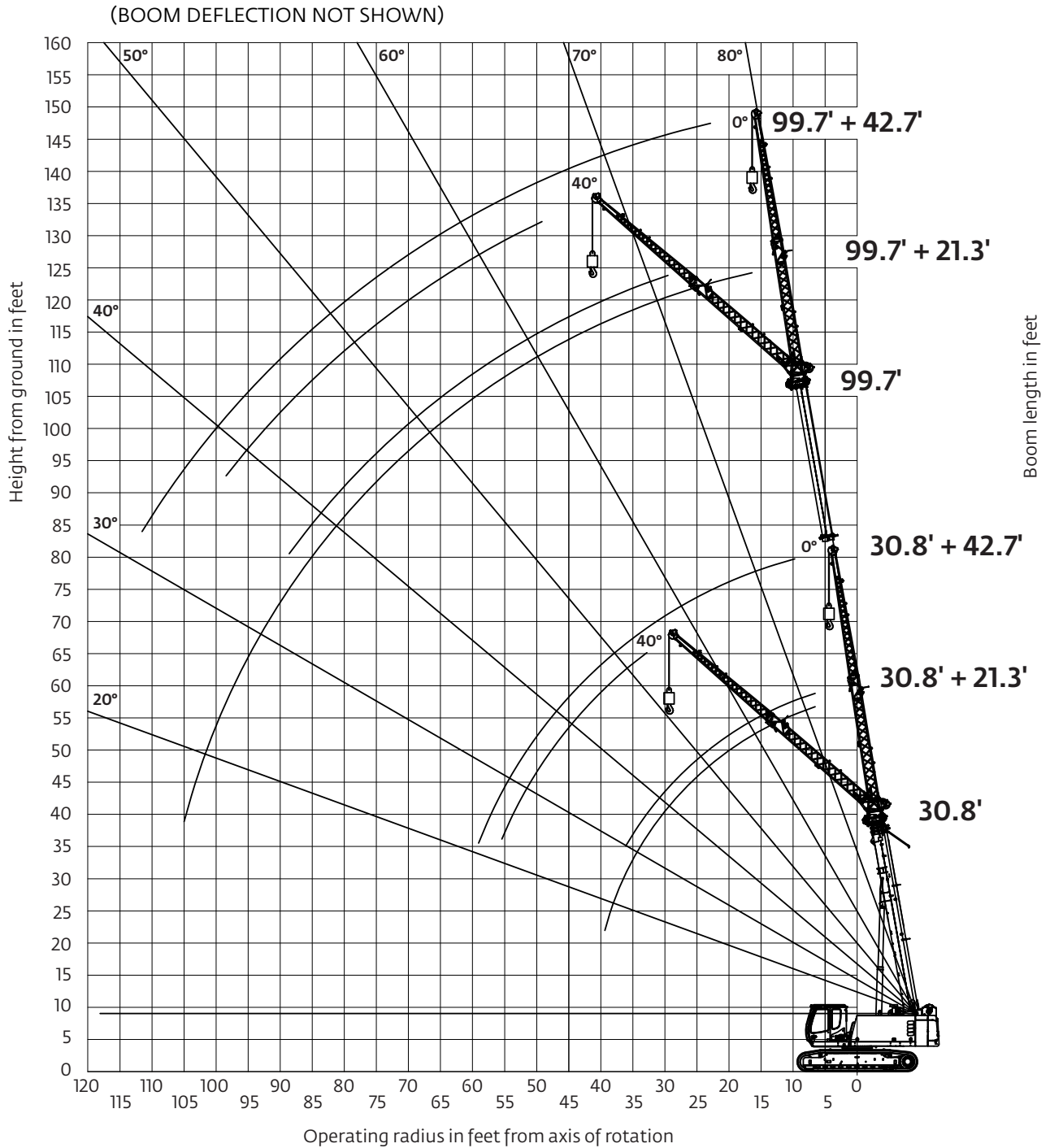

THIS CHART IS ONLY A GUIDE AND SHOULD NOT BE USED TO OPERATE THE CRANE.
The individual crane's load chart, operating instructions and other instructional plates must be read and understood prior to operating the crane.

Load chart

Extensions – imperial 75%



99 ft 9 in



21 ft 4 in



19,621 lb



100%



360°



Pounds

Radius in feet	Main boom length in feet							
	30.8		53.5		76.4		99.7	
	0°	40°	0°	40°	0°	40°	0°	40°
7	22,100	—	—	—	—	—	—	—
10	21,700	—	22,000	—	21,800	—	—	—
15	17,900	—	21,100	—	20,200	—	—	—
20	15,100	9700	19,100	10,100	18,700	—	10,700	—
25	13,000	9100	16,800	9700	17,100	9600	10,500	—
30	11,400	8600	15,000	9200	15,700	9300	10,400	8800
35	10,200	8300	13,600	8900	14,600	9000	10,400	8700
40	—	—	12,300	8600	13,500	8700	10,300	8400
45	—	—	11,300	8300	12,700	8400	9800	8200
50	—	—	10,400	8200	11,800	8200	9100	8000
55	—	—	9500	—	10,400	8100	8500	7700
60	—	—	—	—	8900	7900	8000	7400
65	—	—	—	—	7800	7800	7500	7100
70	—	—	—	—	6800	—	7000	6800
75	—	—	—	—	5800	—	6000	6200
80	—	—	—	—	—	—	5100	5600
85	—	—	—	—	—	—	4500	4900
90	—	—	—	—	—	—	3900	—
95	—	—	—	—	—	—	3300	—
100	—	—	—	—	—	—	2900	—

THIS CHART IS ONLY A GUIDE AND SHOULD NOT BE USED TO OPERATE THE CRANE.

The individual crane's load chart, operating instructions and other instructional plates must be read and understood prior to operating the crane.

Load chart

Extensions – imperial 75%



99 ft 9 in



42 ft 8 in



19,621 lb



100%



360°



Pounds

Radius in feet	Main boom length in feet							
	30.8		53.5		76.4		99.7	
	0°	40°	0°	40°	0°	40°	0°	40°
10	10,200	—	—	—	—	—	—	—
15	9100	—	9900	—	—	—	—	—
20	8000	—	9000	—	8100	—	—	—
25	7100	—	8100	—	7700	—	4600	—
30	6300	—	7400	—	7200	—	4600	—
35	5600	3900	6700	—	6700	—	4600	—
40	5000	3700	6100	3800	6200	—	4600	—
45	4600	3600	5600	3700	5800	3600	4600	—
50	4200	3400	5200	3500	5500	3500	4600	3300
55	3800	3300	4800	3400	5100	3400	4600	3300
60	—	—	4400	3300	4800	3300	4600	3200
65	—	—	4100	3200	4600	3200	4400	3100
70	—	—	3900	3100	4300	3200	4200	3100
75	—	—	3600	—	4100	3100	4000	3100
80	—	—	—	—	3900	3000	3900	2900
85	—	—	—	—	3800	3000	3800	2900
90	—	—	—	—	3400	—	3500	2900
95	—	—	—	—	3200	—	3400	2900
100	—	—	—	—	—	—	3300	2900
105	—	—	—	—	—	—	3100	—
110	—	—	—	—	—	—	2800	—
115	—	—	—	—	—	—	2400	—
120	—	—	—	—	—	—	2100	—
125	—	—	—	—	—	—	1900	—

THIS CHART IS ONLY A GUIDE AND SHOULD NOT BE USED TO OPERATE THE CRANE.
The individual crane's load chart, operating instructions and other instructional plates must be read and understood prior to operating the crane.

Load handling

Weight reductions for load handling devices		
6,5 m - 13,0 m (21.3 ft - 42.7 ft) Boom extension:		
	Without block or ball	With 80 kg (176 lb) headache ball
*6,5 m (21.3 ft) extension (erected)	800 kg (1764 lb)	942 kg (2077 lb)
*13,0 m (42.7 ft) extension (erected)	1332 kg (2936 lb)	1532 kg (3377 lb)
Hook blocks and Headache ball:		
60 t (66 USt), 6-sheave		850 kg+ (1875 lb+)
35 t (38.5 USt), 3-sheave		270 kg+ (595 lb+)
5 t (5.5 USt), headache ball		80 kg+ (176 lb+)

*Reduction of main boom capacities
+Refer to rating plate for actual weight

When lifting over swingaway and/or jib combinations, deduct total weight of all load handling devices reeved over main boom nose directly from swingaway or jib capacity.

NOTE: All load handling devices and boom attachments are considered part of the load and suitable allowances MUST BE MADE for their combined weights. Weights are for Grove furnished equipment.

Line pulls and reeving information			
Hoists	Cable specs	Permissible line pulls	Nominal cable length
Main and auxiliary	16 mm (5/8") Verotop Rotation Resistant (non-rotating) Min. breaking strength 24 900 kg (54,895 lb)	5000 kg (11,000 lb*)	170 m (557 ft)
Main and auxiliary	16 mm (5/8") 35x7 Class Rotation Resistant (non-rotating) Min. breaking strength 27 760 kg (61,200 lb)	5000 kg (11,000 lb*)	170 m (557 ft)

The approximate weight of Verotop 16 mm (5/8") wire rope is 1,25 kg/m (0.84 lb/ft).
The approximate weight of 35x7 class 16 mm (5/8") wire rope is 1,5 kg/m (1.0 lb/ft).

*With certain boom and hoist tackle combinations, the allowable line pull may be limited by hoist performance. Refer to Hoist Performance table for lift planning to ensure adequate hoist performance on drum rope layer required.

Hoist performance				
Wire rope layer	Hoist line pulls two-speed hoist		Drum rope capacity	
	Low available*	High available*	Layer	Total
1	6455 kg (14,230 lb)	3742 kg (8250 lb)	26,5 m (86.8 ft)	26,5 m (86.8 ft)
2	6056 kg (13,352 lb)	3511 kg (7741 lb)	28,2 m (92.5 ft)	54,7 m (179.3 ft)
3	5704 kg (12,575 lb)	3307 kg (7291 lb)	29,9 m (98.2 ft)	84,6 m (277.5 ft)
4	5390 kg (11,884 lb)	3125 kg (6890 lb)	31,7 m (103.9 ft)	116,3 m (381.4 ft)
5	5109 kg (11,264 lb)	2962 kg (6531 lb)	33,4 m (109.7 ft)	149,7 m (491.1 ft)
6	4857 kg (10,707 lb)	2815 kg (6207 lb)	35,1 m (115.3 ft)	184,8 m (606.4 ft)
7	4627 kg (10,201 lb)	2683 kg (5915 lb)	36,9 m (121.1 ft)	221,7 m (727.5 ft)

*Max lifting capacity: Verotop and 35x7 class rope = 5000 kg (11,000 lb)

Working area diagram

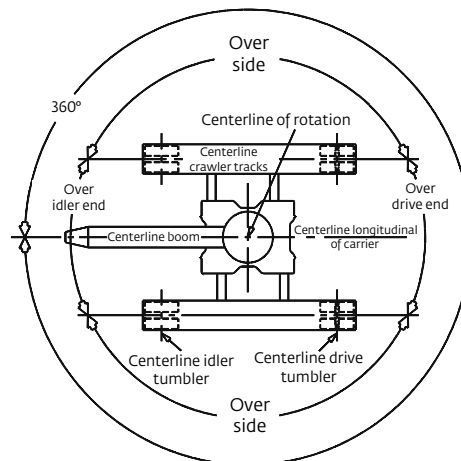

THIS CHART IS ONLY A GUIDE AND SHOULD NOT BE USED TO OPERATE THE CRANE.

The individual crane's load chart, operating instructions and other instructional plates must be read and understood prior to operating the crane.

Upper carriage



Standard boom

9,4 m – 30,4 m (30 ft 10 in – 99 ft 9 in) Four-section, full power, sequenced-synchronized telescopic boom.
Maximum tip height: 32,6 m (107 ft)



Boom extension

6,5 m (21 ft 4 in) offsettable, lattice, one piece swingaway extension. Extension can be offset at 0° and 40°.
Maximum tip height: 39,3 m (129 ft)



*Optional boom extension

6,5 m (21 ft 4 in) offsettable, lattice, bi-fold swingaway extension that must be used in conjunction with standard 6,5 (21 ft 4 in) boom extension. This provides a total of 13 m (42 ft 8 in) of additional reach.
Maximum tip height: 45,4 m (149 ft)
Boom extension can be offset 0° and 40°



Boom nose

Five nylatron sheaves on heavy-duty roller bearings with removable rope guards. Quick reeve type boom nose.
Equipped with removable auxiliary boom nose.



Boom elevation

One double-acting hydraulic cylinder with integral holding valves.
Elevation: -6° to 80°



Rated capacity limiter and anti-two block system

Load moment and independent anti-two block system with audio visual warning and control lever lock-out. These systems provide graphic display of boom angle, length, radius, tip height, relative load moment, maximum permissible load, load indication and warning of impending two-block condition with lock-out hoist function.



Counterweight

8900 kg (19,621 lb) total (2 pieces)



Cab

Large capacity operator's compartment that includes an air suspended operator's seat with lumbar support, heated seat, headrest, 3 inch safety belt, ergonomic control panels, load sensing electric dual axis joystick controls, travel pedals and levers, exceptional sound insulation, sliding door (includes sliding window), excellent all around visibility, tinted safety glass, front tilt window, large skylight w/ sun protection, windshield and roof wiper/washer system, radio w/ CD player, climate control (A/C, heat and defrost), fire extinguisher, and 15° tilt capability for improved overhead vision and ergonomic posture. Also equipped with a 7 inch monitor in cab for rear view, right side and hoist cameras.



Swing

Two-speed, compact planetary gears with slant axis hydraulic motor and integrated brake valves. Sealed, externally geared slewing ring that allows for 360° of continuous rotation. Electronically applied service brake operated via foot pedal. Spring applied, hydraulically released parking brake. One position, manually pinned house lock.
Swing speed: 0 – 2 rpm, variable



Hydraulic system

Load sensing / LUDV hydraulic system with hydraulic and pilot controlled work functions, and load limit sensing control. Single variable-displacement piston pump with a two-section gear pump.
Maximum output: 315 lpm (83.2 gpm)
Maximum operating pressure: 330 bar (4,786 psi)
510 L (134 gal) steel hydraulic reservoir with sight level gauge. High performance, 3 micron filtration system with water absorption contamination indicator for higher oil purity and extended oil service life.



Hoist specifications (main and auxiliary)

Two-speed hoists driven via an axial piston hydraulic motor with compact planetary gear. Spring-loaded disc brake. Grooved drum with drum rotation indicator for both hoists that is located in the joystick controls.
Maximum hoist pull (first layer): 6455 kg (14,230 lb)
Maximum permissible single line pull: 4990 kg (11,000 lb)
Maximum single line speed: 122 m/min (400 ft/min)
Rope construction: 35 X 7 Rotation Resistant
Rope diameter: 16 mm (5/8 in)
Rope length: 170 m (557 ft)



Engine (Tier 4)

Cummins QSB 4.5 L diesel, four cylinders, turbocharged with Cummins Diesel Oxidation Catalyst (DOC) exhaust and Selective Catalytic Reduction (SCR).
Meets USEPA Tier 4 final requirements.
129 kW (173 bhp) at 2500 rpm.
Fuel requirements: Maximum of 15 ppm sulphur content (ultra-low diesel fuel). DEF (diesel exhaust fluid) required for SCR (selective catalytic reduction).
NOTE: Tier 4 engine required for sale in North America.



Engine (Tier 3)

Cummins QSB 4.5 L diesel, four cylinders, turbocharged rated at 119 kW (160 bhp) at 2200 rpm.
NOTE: Required for sale outside of North America.



Fuel tank capacity

Diesel Fuel: 360 L (95 gal)
DEF (diesel exhaust fluid): 38 L (10 gal)

Specifications

Upper carriage *cont'd*



Electrical system

24 volt with two 12-volt, maintenance-free batteries. Includes battery disconnect switch.



Lights

Lighting package includes two halogen lights integrated into the front side of the cab roof and one LED headlight on the upper carriage, right side.

Lower carriage



Frame

Durable all steel welded construction with extendable cross members.



Side frames

Four steel side frame beams that can be hydraulically extended or retracted via controls in the cab. 900 mm (36 in) triple bar maintenance free track shoes.

Retracted gauge: 2,60 m (8 ft 6 in)

Intermediate gauge: 3,30 m (10 ft 10 in)

Extended gauge: 4,10 m (13 ft 6 in)

*Note: These widths are from centerline to centerline of crawlers.



Travel

Two-speed hydrostatic drive operated via lever/pedal controls in cab. Allows for excellent maneuverability with skid steering and counter-rotation. Both side frames are hydraulically driven through a two-stage hydraulic traction motor. Spring-loaded, hydraulically venting disk brake.

Travel Speed: Max Low Range – 1,37 kmh (0.85 mph)

Max High Range – 2,49 kmh (1.55 mph)

Gradeability (theoretical): 70%

Operating weight

45 770 kg (100,905 lb) base machine configuration that includes 30,4 m (99 ft 9 in) boom, 6,5 m (21 ft 4 in) extension, 35 t (38.5 USt) hook block, 900 mm (36 in) triple bar shoes, main and auxiliary hoist, and 8900 kg (19,621 lb) counterweight.

Ground bearing pressure (no load): 0,53 kg/cm² (7.47 psi)

Miscellaneous standard equipment

- Central, easily accessible lubricating strip for slewing ring.
- Foldable grated platforms on the side of cab and both sides of the upper carriage.
- Storage box attached to the rear frame.
- Service friendly engine and hydraulic compartments with decoupled engine suspension, sound proofing and lighting.
- 35 t (38.5 USt) three-sheave, quick reeve hook block.
- External RCL light bar.
- CraneStar asset management system.

*Optional equipment

- Auger Ready Package: Includes hoses and pipes at the base boom, auger hydraulic circuit 150 L/min (39 gpm), 175 bar (2500 psi), controls and switches in the cab for auger operation.
- Auger Motor and Kelly Bar: Includes stowage brackets, hydraulic hoses to connect to the auger ready package plumbing, the auger motor and Kelly bar.
- Auger Flightings: 609 mm (24 in), 914 mm (36 in) and 1219 mm (48 in) available.
- Pole Claw Preparation / Tool Circuit: Provides 35 L/min (9 gpm), 175 bar (2500 psi) through a 32 m (105 ft) hose reel with quick disconnect fittings, switch for tilting and clamping function, controls and switches in the cab.
- Pole claw.
- Basket: Yoke style, 72 in x 36 in (1829 mm x 914 mm) steel basket, gravity hung with cylinder brake lock (does not side stow). Includes quick-attach boom attachments for the main boom and standard 6,5 m (21 ft 4 in) boom extension. Basket capacities: 544,3 kg (1200 lb) main boom and 226,7 kg (500 lb) on boom extension.
- Radio remote control package.
- Cold weather packages up to -40° C / -40° F.
- Maintenance-free flat track shoes.
- Swing barrier protection.
- Polyurethane clamp-on tack pads.

Symbols glossary



Boom



Counterweight



Grade



Radius



Boom elevation



Electrical system



Hoist



Rotation



Boom extension



Engine



Hook block



Side Frames



Boom length



Extension



Hydraulic system



Speed



Boom nose



Frame



Lights



Swing



Cab



Fuel tank capacity



Oil

Manitowoc Cranes

Regional headquarters

Americas

Manitowoc, Wisconsin, USA

Tel: +1 920 684 6621

Fax: +1 920 683 6277

Shady Grove, Pennsylvania, USA

Tel: +1 717 597 8121

Fax: +1 717 597 4062

Europe, Middle East, Africa

Dardilly, France

Tel: +33 (0)4 72 18 20 20

Fax: +33 (0)4 72 18 20 00

China

Shanghai, China

Tel: +86 21 6457 0066

Fax: +86 21 6457 4955

Greater Asia-Pacific

Singapore

Tel: +65 6264 1188

Fax: +65 6862 4040



Manitowoc Crane Care when you need it.

The assurance of the world's most advanced crane service and support to get you back to work fast.



Manitowoc Finance helps you get right to work generating profits for your business.

Financial tools that help you capitalize on opportunity with solutions that fit your needs.

This document is non-contractual. Constant improvement and engineering progress make it necessary that we reserve the right to make specification, equipment, and price changes without notice. Illustrations shown may include optional equipment and accessories and may not include all standard equipment.